

Progettare il nuovo con uno sguardo alla tradizione

L'arredo contemporaneo gioca con le proporzioni e la fisicità del disegno più tradizionale. Forme di grande spessore senza tempo, lavorazioni di alta ebanisteria, cura nell'accostamento di essenze e cuoio, linee morbide sono gli elementi per trasformare simboli dello status in un progetto che trasmette solidità con la leggerezza di un segno.

Planning novelty with an eye on tradition.

Contemporary furnishings play with the proportions and physical appeal of more traditional design. Extra thick timeless shapes, workmanship borrowed from master cabinet-making, impeccable combinations of wood finishes and leather, and soft silhouettes are the ingredients in the transformation of status symbols into a design that conveys solidity with the light weight of a sign.

Concevoir le neuf dans la perspective de la tradition. Le mobilier contemporain joue avec les proportions et la matérialité de la conception la plus traditionnelle. Des formes intemporelles épaisses, un travail de haute ébénisterie, un soin dans la combinaison de bois et de cuir, des lignes douces sont les éléments servant à transformer les symboles du statut en un projet qui transmet la solidité avec la légèreté d'un signe.

Neue, jedoch traditionsgemäße Projekte. Die moderne Einrichtung spielt mit Proportionen und Formen des traditionellen Designs. Zeitlose, massive Formen, hochwertige Tischlerarbeiten, sorgfältige Kombinationen von verschiedenen Materialien mit Leder und weiche Linien sind die Besonderheiten, die Statussymbole in ein Projekt verwandeln, das Stabilität und auch Leichtigkeit vermittelt.

Proyectar lo nuevo inspirándose en la tradición.

El mobiliario contemporáneo juega con las proporciones y la fisicidad del diseño más tradicional. Formas de gran grosor sin tiempo, elaboraciones de ebanistería de calidad, atención en las combinaciones de esencias y cuero y líneas suaves son los elementos para transformar símbolos del estatus en un proyecto que transmite resistencia con la ligereza de una línea.

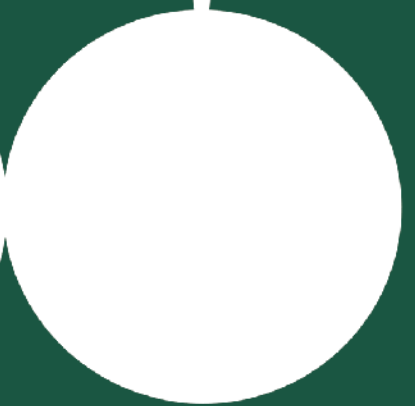
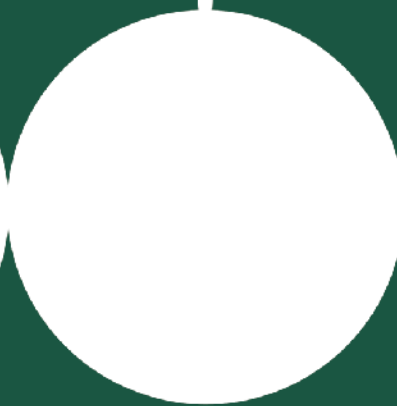
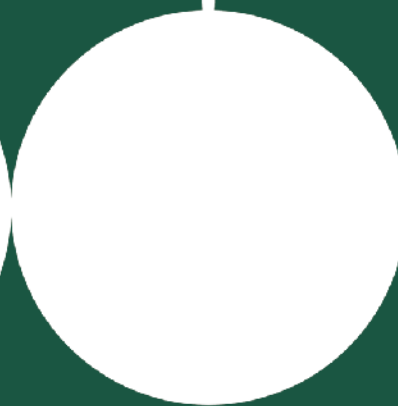
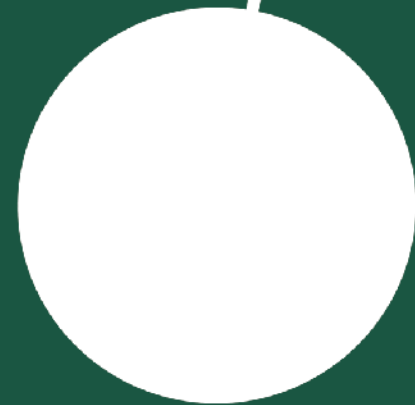





Elogio dell'equilibrio tra materia e forma.

Le scrivanie privilegiano l'eleganza delle forme e la ricchezza nella composizione dei volumi, trasformandosi immediatamente in simbolo della modernità. Elementi rigorosi, contrasti visuali, linee inclinate e giochi compositivi delimitano le superfici della scrivania direzionale. Matericità e tonalità eleganti per il gusto del manager contemporaneo.

Praise to the balance between material and form. The desks make way for elegant shapes and wealthy volume compositions, immediately turning into a symbol of modernity. Strikingly simple elements, visual contrasts, slanted silhouettes and games of compositions delineate the surfaces of the executive desk. Elegant colours and textures to accommodate the tastes of the contemporary manager.

Éloge de l'équilibre entre la matière et la forme.

Les bureaux privilégient l'élégance des formes et la richesse dans la composition des volumes, en se transformant immédiatement en un symbole de la modernité. Des éléments stricts, des contrastes visuels, des lignes inclinées et des jeux de composition délimitent les surfaces du bureau de direction. Matérialité et nuances élégantes pour satisfaire le goût du manager contemporain.

Ausgewogenheit zwischen Material und Form. Die Schreibtische weisen vorzugsweise elegante Formen und vielfältige Kombinationen auf und verwandeln sich geradewegs in moderne Symbole.

Präzise Elemente, optische Kontraste, schräge Linien und spielerische Kombinationen zeichnen die Flächen des Direktionsschreibtisches aus. Elegante Formen und Farbtöne treffen den Geschmack des modernen Managers.

Elogio del equilibrio entre materia y forma. Los escritorios dan prioridad a la elegancia de las formas y a la riqueza en la composición de los volúmenes, transformándose de forma inmediata en símbolo de la modernidad.

Elementos rigurosos, contrastes visuales, líneas inclinadas y juegos de composición delimitan las superficies del escritorio de dirección. Matericidad y tonalidades elegantes para el gusto del director contemporáneo.



L'idea di uno spazio puro e incontaminato.

Un'organizzazione moderna delle aree funzionali in cui l'arredo diventa fulcro di un ufficio creato per generare: sensazioni, incontri, socialità e operatività. Le ampie superfici di lavoro definiscono soluzioni in cui l'ufficio è vissuto in piena continuità con l'ambiente.

The idea of a pure and uncontaminated space. A modern organisation of functional areas in which the furnishings become the fulcrum of an office created to generate sensations, encounters, socialising and efficiency. The ample work surfaces define solutions in which the office is experienced in perfect harmony with the environment.

L'idée d'un espace pur et non contaminé. Une organisation moderne des zones fonctionnelles où l'ameublement devient le cœur d'un bureau créé pour générer: sensations, rencontres, socialité et opérativité. Les amples surfaces de travail définissent des solutions où le bureau est vécu en pleine continuité avec l'environnement.

Die Vorstellung eines puren, nicht kontaminierten Raums. Eine moderne Organisation der Funktionsbereiche, in denen die Inneneinrichtung der Angelpunkt eines regsamen Bürobetriebs ist: Eindrücke, Meetings, Gemeinschaftssinn und Geschäftigkeit. Die großen Arbeitsflächen führen zu Gestaltungen, in denen der Büroraum als Kontinuität des Ambientes erlebt wird.

La idea de un espacio puro y limpio. La moderna organización de las áreas funcionales en las que los muebles se convierten en el punto de apoyo de una oficina creada para generar sensaciones, encuentros, socialización y operatividad. Las amplias superficies de trabajo crean soluciones para vivir la oficina en sintonía con el medio ambiente.











Il legno sposa il cuoio in soluzioni di alta artigianalità.

Il rapporto tra disegno e proporzioni esalta l'eleganza e la bellezza delle linee pulite e morbide, che caratterizzano la gamba e tutta la superficie del piano scrivania dove l'essenza legno abbinata al cuoio, sapientemente cucito, è un esempio di lavorazione d'eccellenza.

Wood marries leather in solutions marked by superior craftsmanship. The rapport between design and proportions enhances the elegance and the beauty of clean-cut, soft silhouettes, which distinguish the leg and the entire surface of the desk top, where the wood finish combined with finely stitched leather is a prime example of excellent workmanship.

Le bois s'unit au cuir en solutions d'artisanat de grande qualité. La relation entre le design et les proportions exalte l'élégance et la beauté des lignes épurées et douces, qui caractérisent le pied et toute la surface du bureau où l'essence du bois combiné au cuir, cousu de façon experte, témoigne de l'excellent travail réalisé.

Das Holz verbindet sich in hochwertigen Lösungen mit dem Leder. Perfektes Design und angemessene Proportionen betonen die Eleganz und Schönheit der klaren und sanften Linien, die die Tischbeine und die gesamte Oberfläche des Schreibtisches prägen. Das Holz offenbart in Verbindung mit dem erstklassig genähten Leder die hervorragende Verarbeitung.

La madera se combina con el cuero en soluciones de elevada artesanía. La relación entre diseño y proporciones destaca la elegancia y la belleza de las líneas limpias y suaves que caracterizan la pata y toda la superficie del tablero del escritorio donde la esencia de la madera, combinada con el cuero, cosido con gran pericia, es un ejemplo de fabricación de excelencia.







Allargare i limiti dello spazio.

L'armonioso gioco compositivo degli elementi si rivela per risolvere ogni problema di spazio e di utilizzo. I vari elementi concorrono a creare ambienti in cui si fondono valore d'uso e coerenza estetica.

Expanding the limits of space. The harmonious game of combining elements together is revealed to solve any space and usage problem. The various elements contribute towards creating settings where usage value merges with styling consistency.

Étendre les limites de l'espace. Le jeu harmonieux de la composition des éléments se dévoile pour résoudre tout problème d'espace et d'utilisation. Les divers éléments se combinent pour créer des environnements qui allient utilité et cohérence esthétique.

Die Grenzen des Raumes beseitigen. Platz- und Verwendungsfragen lassen sich dank der harmonischen Kombinationen lösen. Die einzelnen Elemente lassen Räume entstehen, in denen Zweckmäßigkeit und ästhetische Schönheit verschmelzen.

Ampliar los límites del espacio. El armonioso juego de composición de los elementos se revela para resolver todos los problemas de espacio y de utilización. Los diversos elementos compiten para crear ambientes en los que se unen el valor del uso y la coherencia estética.



Linee pulite e dettagli di qualità per un ambiente elegante

Unire materiali di prestigio e sintesi nel disegno: questa la caratteristica dei tavoli riunione, un sistema in cui l'essenzialità delle strutture sostiene piani predisposti a connettersi con il mondo.

Clean-cut silhouettes and quality details for a stylish setting. Combining the finest materials with impeccable design: this is the distinguishing trait of these meeting tables, a system where the elemental appeal of the structures supports tops designed to be connected to the world.

Des lignes épurées et des détails de qualité pour un cadre élégant. Unir des matériaux de qualité et la synthèse du design: c'est cela la caractéristique des tables de réunion, un système dans lequel le caractère essentiel des structures supporte des plans prévus pour se connecter avec le monde.

Klare Linien und hochwertige Details für ein elegantes Ambiente. Die Verbindung von wertvollen Materialien mit einem unkomplizierten Design kennzeichnet die Konferenztische, bei denen schlichte Strukturen Tischplatten tragen, die für die Verbindung mit der Welt bestimmt sind.

Líneas limpias y detalles de calidad para un ambiente elegante. Unir materiales de prestigio y síntesis en el diseño: esta es la característica de las mesas de reunión, un sistema en el que la esencialidad de las estructuras sostiene tableros preparados para conectarse con el mundo.







Griglie sotto piano ispezionabili, top access, gambe pannellate ed in tamburato con discesa in verticale consentono una sicura soluzione per i sistemi di comunicazione globale.

Grilles sous plan qui peuvent être inspectées, top access, pieds lambrisés et en nid d'abeille avec descente verticale permettent une solution sécurisée pour les systèmes de communication globale.

Rejillas inferiores inspeccionables, accesos superiores, patas paneladas y en contrachapado con bajada en vertical permiten una solución segura para los sistemas de comunicación global.

Accessible undertop cable tidy baskets, cable flaps, panelled honeycomb legs with inner hollow tower to route cables from the worktop to the floor make for a safe solution for global communication systems.

Leicht zugängliche Untertisch-Gitterablagefächer, Top Access, Paneel- und Wabenpaneelbeine mit vertikaler Kabelführung erlauben eine sichere Lösung für globale Kommunikationssysteme.





Technical informations
 Informations techniques
 Technische Informationen
 Informaciones técnicas



Scrivania autonoma piano in legno.
Autonomous wooden desk.
 Bureau en bois autonome.
Autonome Schreibtisch aus Holz.
 Escritorio de madera autónomo.

Scrivania autonoma piano legno con inserti in cuoio.
Autonomous wooden desk with leather inserts.
 Bureau en bois autonome avec inserts en cuir.
Autonome Schreibtisch aus Holz mit Ledereinsätzen.
 Escritorio de madera autónomo con inserciones de cuero.

Scrivania in legno con elemento di servizio multiuso DX-SX.
Wooden desk with element multi-purpose service DX - SX.
 Bureau en bois avec élément de service multi-usages DX- SX.
Holz-Schreibtisch mit Element Mehrzweck Service DX -SX.
 Escritorio de madera con elemento de servicio polivalente DX - SX .

Scrivania in legno con inserti in cuoio con elemento di servizio multiuso DX-SX.
Wooden desk with leather inserts with element multi-purpose service DX - SX.
 Bureau en bois avec inserts en cuir avec élément de service multi-usages DX- SX.
Holz-Schreibtisch mit Ledereinsätzen mit Element Mehrzweck Service DX -SX.
 Escritorio de madera con inserciones de cuero con elemento de servicio polivalente DX - SX .

Tavoli riunione con piano in legno.
Conference tables with wooden top.
 Tables de conférence avec plateau en bois.
Konferenztische mit Holzplatte.
 Las mesas de reuniones con tapa de madera.

Tavoli riunione con piano con inserti in cuoio.
Conference tables with a worktop with leather inserts.
 Tables de conférence avec un plan de travail avec des inserts en cuir.
Konferenztische mit einer Arbeitsplatte mit Ledereinsätzen.
 Las mesas de reuniones con una superficie de trabajo con inserciones de cuero.

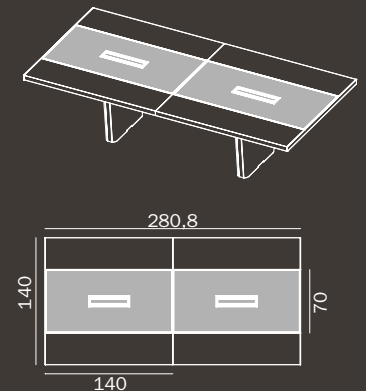
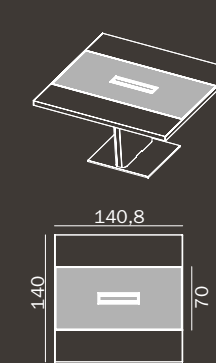
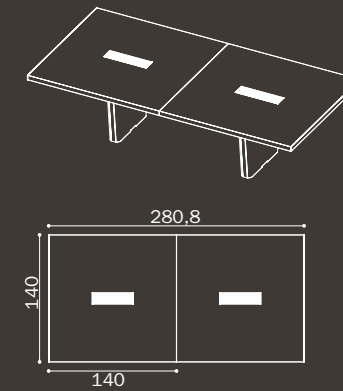
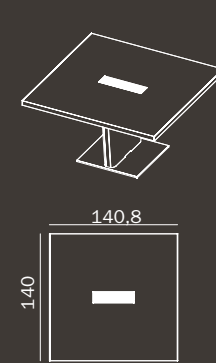
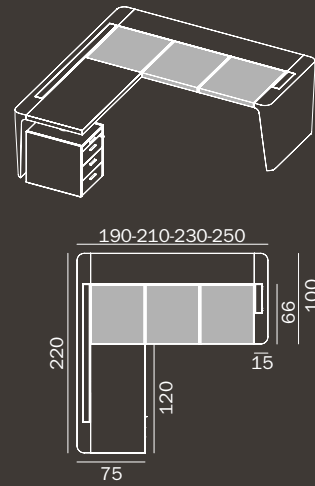
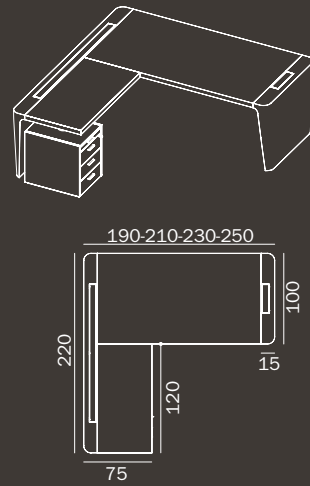
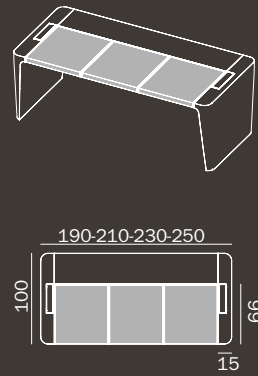
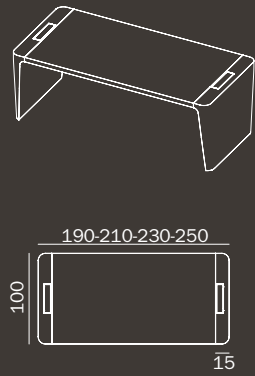

Tavolini da caffè.
Coffee table.
 Table basse.
Kaffetisch.
 Mesa de café.

Cassettiera su ruote
Chest of drawers on wheels
 Caisson sur roues
Schubladen kasten auf Rädern
 Cajonera sobre ruedas

Gonna
Modesty panel
 Voile de fond
Sichtblende
 Faldón

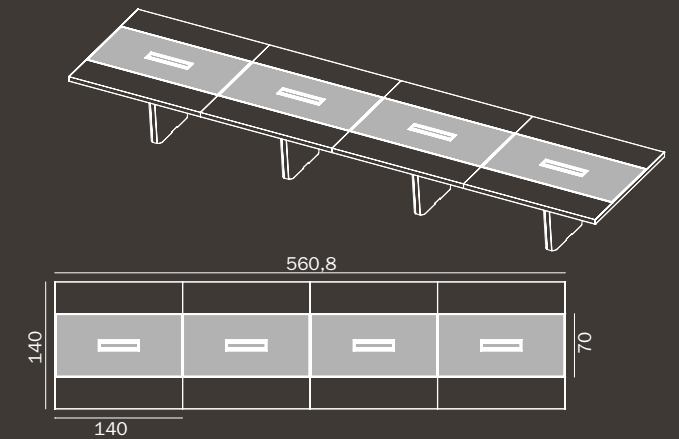
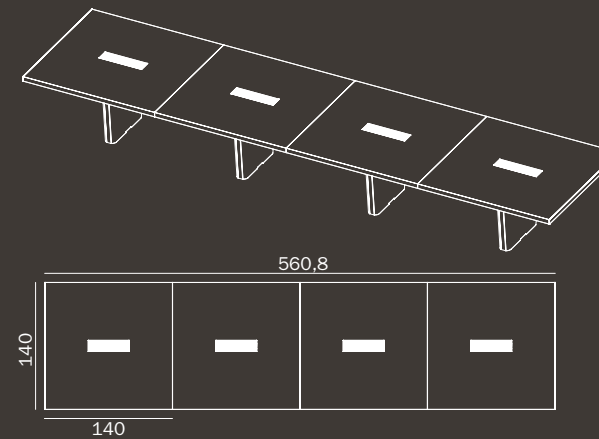
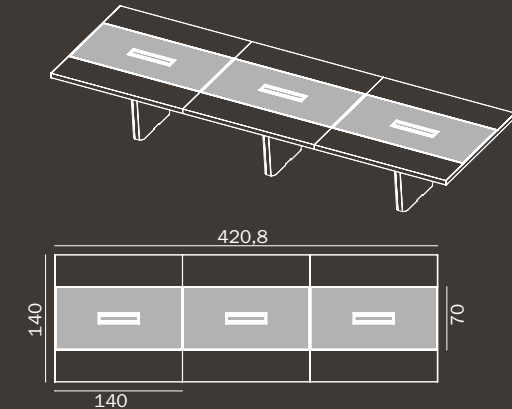
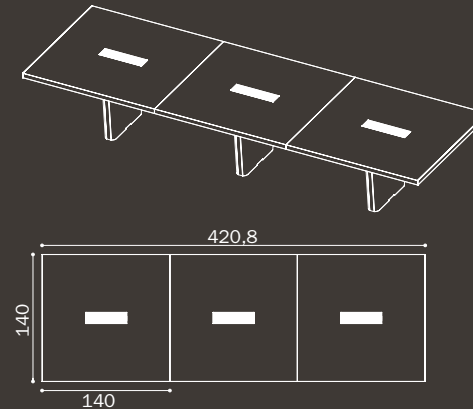
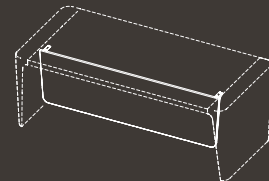
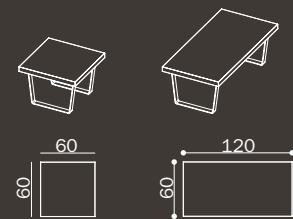



FINITURE

FINISHES
FINITIONS
OBERFLÄCHE
ACABADOS

Melaminico | Melamine | Mélamine | Melamin | Melamina

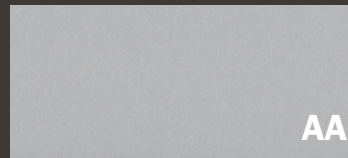

ARGENTO
silver
aluminium
Aluminium
aluminio

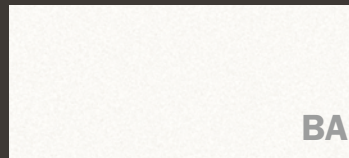

BIANCO
white
blanc
weiss
blanco

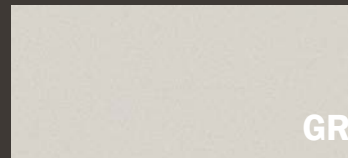

GRIGIO
grey
gris
grau
gris

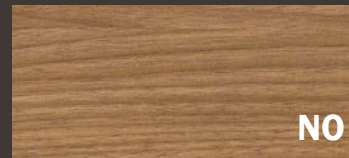

NOCE CANALETTO
canaletto walnut
noyer canaletto
Nuss Canaletto
nogal canaletto

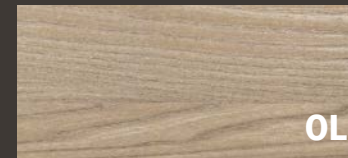

OLMO
elm
orme
Ulme
olmo

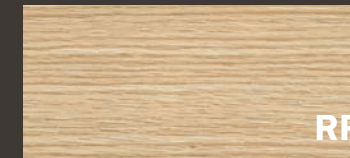

ROVERE
oak
chêne
Eiche hell
roble



WENGÈ
wengè
wenguè
Wengè
wenguè

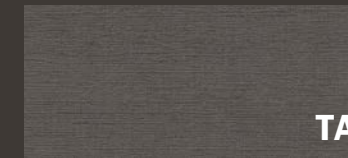

TESSUTO ANTRACITE
anthracite linen
tissu gris
Leinen grau
Lino ceniza

Legno impiallacciato | Wood veneer | Placage bois | Holz furniert | Madera chapada

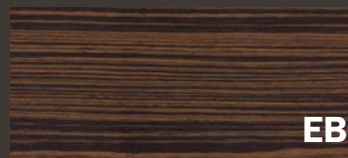

EBANO RIGATINO
ebony
ébène
Ebenholz
ebano



OLMO GRIGIO
elm
orme gris
Ulme grau
olmo gris

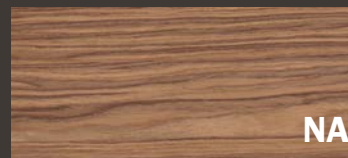

NOCE AMERICANO
american walnut
noyer américain
amerikanischer Nußbaum
nogal americano

Cuoietto | Leather | Cuir | Leder | Piel

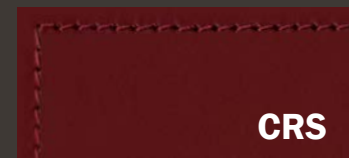

ROSSO
red
rouge
rot
rojo

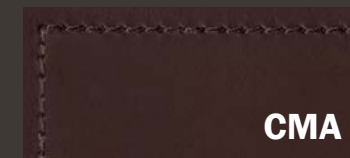

MARRONE
brown
brun
braun
marrón

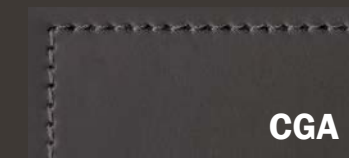

ANTRACITE
anthracite
brun
Anthrazit
antracita

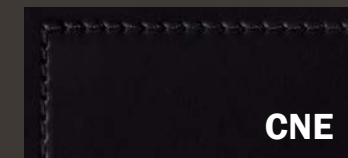

NERO
black
noir
schwarz
negro

Laccato | Lacquer | Laqué | Lackiert | Lacado

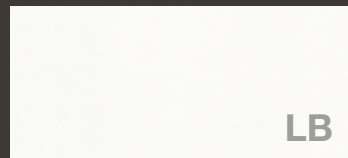

RAL 9003 BIANCO
white
blanc
weiss
blanco

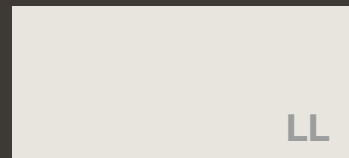

RAL 9002 BIANCO GRIGIASTRO
grey white
blanc gris
grauweiss
blanco grisáceo

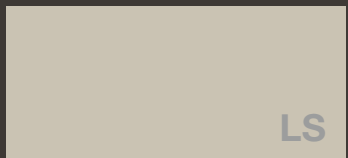

RAL 7044 GRIGIO SETA
silk grey
gris soie
seidengrau
gris seda



RAL 1019 BEIGE
beige
beige
beige
beige

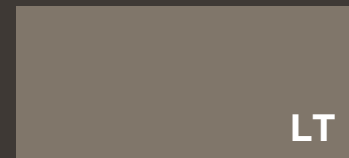

RAL 7006 GRIGIO BEIGE
beige grey
gris beige
beigegrau
gris beige

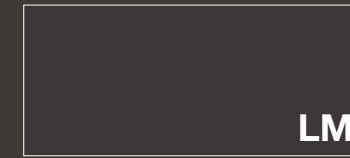

RAL 8019 MARRONE GRIGIASTRO
grey brown
brun gris
graubraun
pardo grisáceo



RAL 1004 GIALLO ORO
golden yellow
jaune or
goldgelb
amarillo oro



RAL 2000 ARANCIONE
orange
orange
orange
naranja



RAL 3000 ROSSO FUOCO
flame red
rouge feu
Feuerrot
rojo vivo



RAL 3004 ROSSO PORPORA
purple red
rouge pourpre
purpurrot
rojo púrpura



RAL 5014 BLU COLOMBA
pigeon blue
bleu pigeon
tauben blau
azul olombino



RAL 5000 BLU VIOLACEO
violet blue
bleu violet
violettblau
azul violeta



RAL 5003 BLU ZAFFIRO
sapphire blue
bleu saphir
saphirblau
azul zafiro

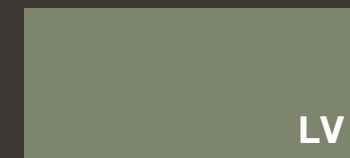

RAL 6013 VERDE
green
vert
grün
verde

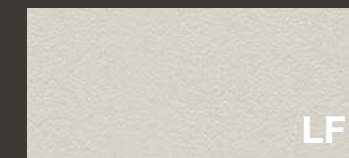

RAL 7047 TELE GRIGIO 4
telegrey 4
telegris 4
telegrau 4
gris tele 4



RAL 7004 GRIGIO
grey
gris
grau
gris



RAL 7022 GRIGIO OMBRA
shadow grey
gris ombre
dunkelgrau
gris grafito



RAL 9017 NERO TRAFFICO
traffic black
noir signalisation
verkehrsschwarz
negro tráfico



FINITURE

FINISHES
FINITIONS
OBERFLÄCHE
ACABADOS

Vetro | Glass | Verre | Glas | Vidrio

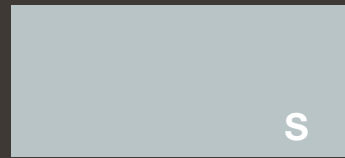

AZZURRATO
light green
acidifié
hellbalu
azulado

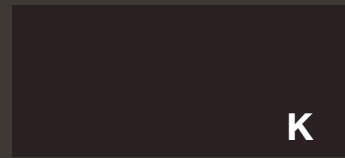

MOKA
moka
moka
moka
moka



ROSSO
red
rouge
rot
rojo

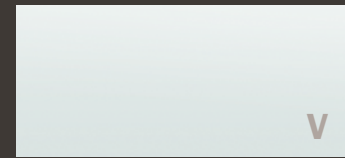

ACIDATO
frosted white
blanc dépoli
weiß gefrostet
vidrio mate

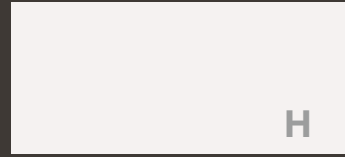

BIANCO OPACO
matt white
blanc opaque
weiß matt
blanco mate

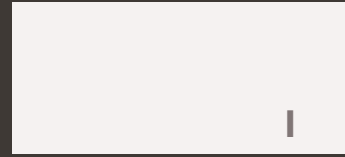

BIANCO
white
blanc
weiß
blanco

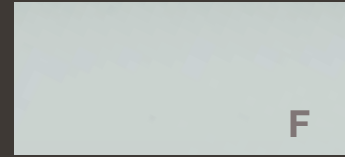

BISATINATO OPACO
double face frosted
double dépoli face
double face bereift
esmerilado de doble cara

Metallo | Metal | Métal | Metall | Metal

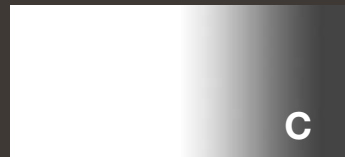

CROMATO
chrome
chromé
verchromt
cromado

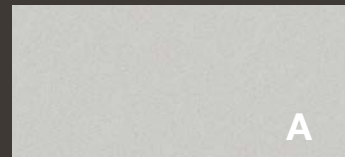

RAL 9006 - ARGENTO
silver
aluminium
silber
aluminio

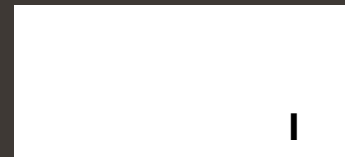

RAL 9016 - BIANCO
white
blanc
weiß
blanco

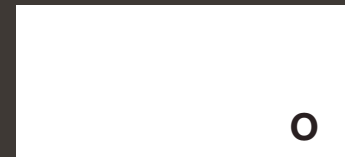

RAL 9010 - BIANCO OPACO
matt white
blanc opaque
weiß matt
blanco mate

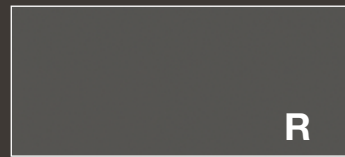

RAL 7022 - GRIGIO OMBRA
shadow grey
gris ombre
dunkelgrau
gris grafito

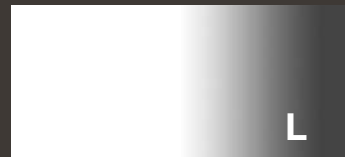

BRILLANTATO CROMO
polished chrome
chrome poli
Chrom poliert
cromo pulido

Tessuto | Fabric | Tissu | Stoff | Tela



GRIGIO
Grey
gris
Grau
Gris

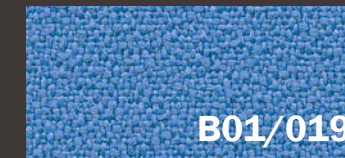

CELESTE
Light blue
Bleu clair
Hellblau
Azul claro



ROSSO
Red
Rouge
Rot
rojo

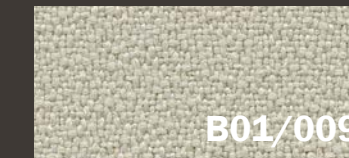

BEIGE
Beige
Beige
Beige
Beige

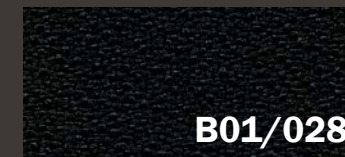

NERO
Black
Noir
Schwarz
Negro



BLU
Blue
Bleu
Blau
Azul



VERDE
Green
Vert
Grün
verde

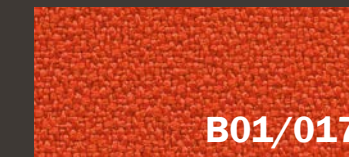

ARANCIONE
Orange
Orange
Orange
naranja

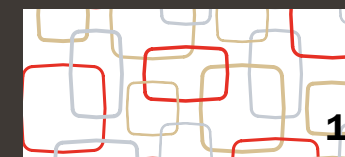

ANELLI ROSSI
Red rings
anneaux rouges
Rote Ringe
anillos rojos



ANELLI BLU
Blue rings
anneaux bleu
Blau Ringe
anillos azul

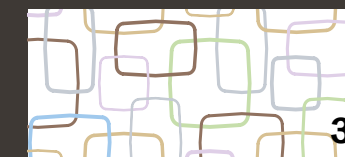

ANELLI MULTICOLORE
Multicolours rings
anneaux multiples couleurs
Multicolours Ringe
anillos Multicolours

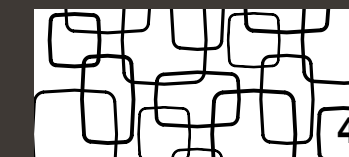

ANELLI NERI
Black rings
anneaux noir
Schwarz Ringe
anillos negro



FONDO NERO
Black background
Fond noir
Schwarzer Hintergrund
Fondo negro



FONDO BEIGE
Beige background
Fond beige
Beige Hintergrund
Fondo beige



FONDO GRIGIO
Grey background
Fond gris
Gräu Hintergrund
Fondo gris



ABBINAMENTI FINITURE

MATCHING FINISHES
FINIS ACCORDE
MATCHING OBERFLÄCHE
ACABADOS A JUEGO

Melaminico MELAMINE MELAMINE MELAMINAUSFÜHRUNG MELAMINA	AA	TA	BA	GR	NO	OL	RR	WE	LACCATO Lacquer Laqué Lackiert Lacado
X8 Piani scrivania Plateau / Worktops /Schreibtischplatte / Sobres			X		X	X		X	X
X8 Mobile di servizio Conteneur / Credenza / Multifunktion Box/ Mueble de servicio			X		X	X		X	X
X7 Piani scrivania Plateau / Worktops /Schreibtischplatte / Sobres			X		X	X		X	X
X7 Mobile di servizio Conteneur / Storage compartment / Multifunktion Box/ Mueble de servicio			X		X	X		X	X
X5 Piani scrivania Plateau / Worktops /Schreibtischplatte / Sobres			X	X	X	X	X	X	
X5 Gonna Vdf/ Modesty panel / Sichtschutz/ Faldón			X	X	X	X	X	X	
X4 Piani scrivania Plateau / Worktops /Schreibtischplatte / Sobres			X	X	X	X	X	X	
X4 Gonna Vdf / Modesty panel / Sichtschutz/Faldón			X	X	X	X	X	X	
Z2 Moduli Comptoir / Modules / Module / Módulos			X		X	X		X	
Z2 Piani scrivania Plateau / Worktops / Schreibtischplatte /Sobres			X		X	X		X	
Z2 Mensola accoglienza top superposé / Upper module / Empfang Ablage/ Applique			X		X	X		X	X
X9 Mobile di servizio Conteneur/ Storage compartment /Multifunktion Box/ Mueble de servicio									X
Cassettiere Caissons / Pedestals / Container / Bucs			X	X	X	X	X	X	X
Ante armadi Portes armoires / Cabinet doors / Türen /Puertas armarios			X	X	X	X	X	X	X
Struttura armadi Corps armoires / Cabinet carcass / Korpus / Cuerpo Armarios	X	X	X						
Struttura box Corps Box / Box carcass / Korpus Box/ Cuerpo box	X	X	X						
Cassettiera box caisson box/ Pedestal for box / Container für Box / Buc para box	X		X						
Ante scorrevoli per box porte coulissantes box / Sliding doors for box Schiebetüren für Box /Puertas correderas box			X	X	X	X	X	X	
Armadi scorrevoli Armoires coulissantes / Cabinets with sliding doors Schiebetürenschränk/ Armarios de puertas correderas			X	X	X	X	X	X	
Ante e frontali archiviazione complanare Portes et façades armoires et caisson HB / Doors and fronts for DH cabinets and pedestals / Türen und Fronten für Tischhöhe Möbel und Container/Puertas y frente cajones armarios y bus H. mesa			X	X	X	X	X	X	

Melaminico MELAMINE MELAMINE MELAMINAUSFÜHRUNG MELAMINA	AA	TA	BA	GR	NO	OL	RR	WE	LACCATO Lacquer Laqué Lackiert Lacado
Struttura archiviazione complanare Structure armoires HB / Carcass for DH cabinets and pedestals Korpus für Tischhöhe Möbel und Container/ Cuerpo armarios y bucs H. mesa	X	X	X						
Top e fianchi 18mm Dessus et parements ép. 18 mm / Finishing tops and sides 18mm Abdeckplatte und Abschlußseiten 18mm/ Sobres y laterales esp. 18mm.			X	X	X	X	X	X	X
Top e fianchi 30mm Dessus et parements ép. 30 mm / Finishing tops and sides 30mm Abdeckplatte und Abschlußseiten 30mm/Sobres y laterales esp. 30mm.			X	X	X	X	X	X	
Pannelli screen Screen / Screen / Screen	X	X	X	X	X	X	X	X	
Boiserie Ante e schienali Portes et dos / Boiserie doors and backs /Türen/ Puertas y trasera Boiserie			X		X	X		X	X
Libreria Struttura Structure /Structure / Gestell/ Cuerpo			X		X	X		X	
Libreria Ante Portes / Library doors / Türen /Puertas			X	X	X	X	X	X	X

Legno/Cuoio BOIS ET CUIR WOOD VENEER AND LEATHER HOLZ UND LEDER MADERA CHAPADA Y PIEL	OG	NA	EB	CRS	CMA	CGA	CNE		
X10 Scrivania Plateau / Desk / Schreibtischplatte /Mesa	X	X	X						
X10 Insetto piani scrivania Insert plateau / Worktop inlay / Leder Einsatz/ Vade integrado				X	X	X	X		
X10 Dattilo con cassettera retour avec caisson / Return unit with pedestal Ansatztsch mit Container/ Buc con ala	X	X	X						
X9 Piani scrivania Plateau / Worktops /Schreibtischplatte / Sobres	X	X	X						
X9 Insetto piani scrivania Insert plateau / Worktop inlay / Leder Einsatz/ Vade integrado				X	X	X	X		
X9 Mobile di servizio Conteneur / Storage compartment / Multifunktions-Box/ Mueble de servicio	X	X	X						
X9 Gonna Vdf / Modesty panel / Sichtschutz/Faldón	X	X	X						
Z2 Mensola accoglienza top superposé / Upper module / Empfang Ablage/Aplique				X	X	X	X		
Ante armadi Porte armoires / Cabinet doors /Türen/ Puertas armarios	X	X	X	X	X	X	X		
Top e fianchi 30mm Dessus et parements ép. 30 mm / Finishing tops and sides 30mm Abdeckplatte und Abschlußseiten 30mm/Sobres y laterales esp. 30mm.	X	X	X	X	X	X	X		



ABBINAMENTI FINITURE

MATCHING FINISHES
FINIS ACCORDE
MATCHING OBERFLÄCHE
ACABADOS A JUEGO

Vetro VERRE GLASS GLAS CRISTAL	H	S	K	R	V	F	I	GE	
X8 Piani scrivania Plateau / Worktops/Schreibtischplatte / Sobres	X								
X7 Piani scrivania Plateau / Worktops/Schreibtischplatte / Sobres	X								
X4 Piani scrivania Plateau / Worktops/Schreibtischplatte / Sobres		X	X	X			X		
Ripiani Boiserie Etagere / Boiserie shelves/Fachböden / Estantes Boisierie	X								
Ante vetro con telaio Porte verre avec cadre / Glass doors with frame Glastüren mit Rahmen / Puertas en cristal con marco					X				
Ante vetro senza telaio Porte verre sans cadre / Glass doors without frame Glastüren ohne Rahmen / Puertas en cristal sin marco								X	
Divisorio per binari Rail / Screen for rail/Trennwand für Führungsschiene / Separador para perfil						X			

Tessuto TISSU FABRIC STOFF TAPIZADO	B01/012	B01/019	B01/018	B01/009	B01/028	B01/023	B01/013	B01/017	
Screen Screen / Screen/Screen / Screen	X	X	X	X	X	X	X	X	
Divisori per piano Cloisonettes / Screen/Trennwand / Separadores	X	X	X	X	X	X	X	X	
Cuscini per box Cousin pour box / Cushion for box/Kissen für Box / Cojines para box	X	X	X	X					
Cuscini per cassettiera Cousin pour caisson / Cushion for pedestal/Kissen für Container / Cojines para buc	X	X	X	X					

Metallo MÉTAL METAL METALL METAL	O	R	A	I	C	L		
X9 Struttura Structure / Structure/Gestell / Estructura	X	X						
X8 Struttura Structure / Structure/Gestell / Estructura	X	X						
X8 Gonna Vdf / Modesty panel/Sichtblende / Faldón	X	X						
X7 Struttura Structure / Structure/ Gestell / Estructura	X				X			
X5 Struttura Structure / Structure/Gestell / Estructura		X		X				
X4 Struttura Structure / Structure/Gestell / Estructura		X	X	X	X			
X4 Gonna Vdf / Modesty panel/Sichtblende / Faldón		X	X	X				
Z2 Struttura Structure / Structure/Gestell / Estructura	X		X					
Telaio Screen Cadrescreen / Frame for screen/Rahmen Screen Marco Screen / Puertas en cristal con marco		X	X	X				
Telaio ante vetro Cadre porte vitrée / Frame for glass doors Rahmen Glastüren / Puertas en cristal sin marco			X			X		
Struttura Boiserie Structure Boiserie / Boiserie Structure/Boiserie / Estructura Boisierie	X	X	X	X		X		
Struttura Armadi metallici Structure armoire métal / Carcass for metal cabinets Korpuselemente / Cuerpo armarios en metal		X	X	X				
Cablaggi Cablage / Cable management/Verkabelung / Electrificación		X	X	X				