

Wilkhahn

Occo. 222 range.





Occo and Occo SC

When furnishing contemporary workspaces, one of the biggest challenges is to ensure that the design of the different areas varies but that a common theme prevails throughout. And, with the distinctive shape of the seat shells and the cut-out sections in the backrests, Occo rises to the challenge. These not only give the chair an airy, light appearance and outstanding comfort, but are a common denominator throughout the range. The furniture is the perfect choice anywhere where people come together to interact, learn, develop new concepts or simply just party. Two seat shells, six colors, four types of upholstery and frames produce a grand total of 192 models for multi-purpose or seminar spaces, meetings or company restaurants. The bar stools have been designed to match. They come with a skid base or four legs made of solid wood, as well as seat shells in the six colors and three upholstered types: not upholstered, with a loose felt pad or with seat cushioning.

Table 222/70 with an HPL table top, table 222/90 with an HPL table top, Insit table 780/2 with an oak veneer table top, design: Wolfgang C.R. Mezger, chair 222/31, chair 222/32, chair 221/22, bar stool 223/20, Stitz 201/2, design: Hans Roericht.



Occo Conference and Occo tables.

Roomy, fully upholstered seat shells plus a choice of two backrest heights and six frames add up to 12 types of chair for clubs, cafeterias, lobbies and conference areas. Four-leg chairs with steel or solid wood frames, four-star base frames made of butted tubular steel on glides or five-star base frames on casters can be matched to suit the mood of the interior and ensure comfort in meetings and areas in the middle of rooms. Task chairs with four-star, aluminum bases and active rocking technology or with five-star bases with casters and additional height-adjustment capabilities introduce dynamic comfort to conference rooms and temporary workspaces that require a superior look. And, finally, the matching tables in sitting and standing heights round out the range. As a result, Occo offers a wide range of options to meet any requirements, but conveys one single design concept throughout.

Table 222/71 with a solid oak table top, chair 224/24. Comfortable and in natural materials - the solid oak Occo Conference chairs and Occo tables foster a relaxed atmosphere in clubs and lounges that encourages people to engage with one another. Design jehs+laub

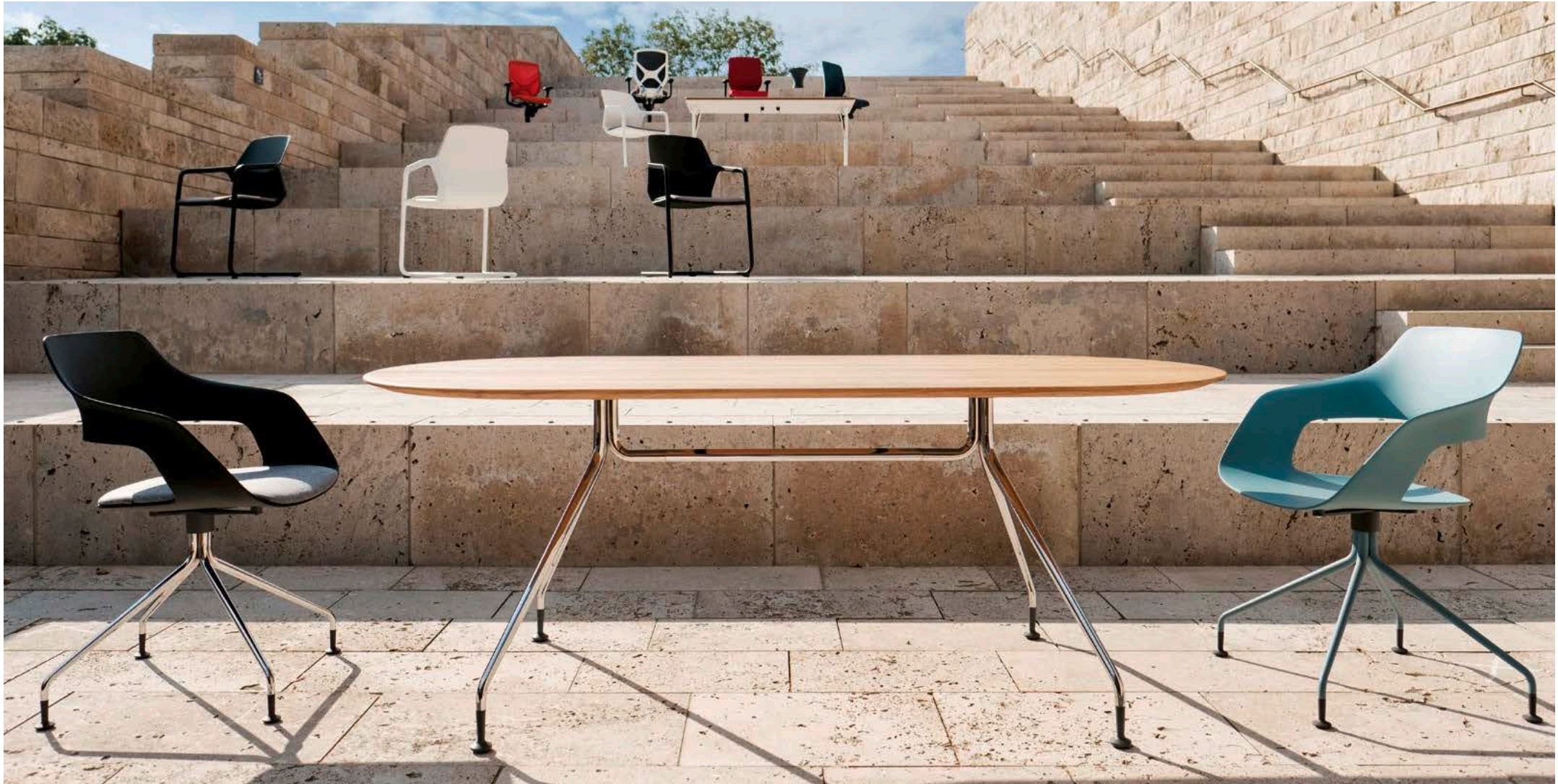

Task chairs 222/31, 222/30 and table 222/90 with a solid oak table top.



Table 222/90 with an HPL table top, chair 222/40 with a felt pad. If non-slip felt pads are kept in storage, models without upholstery can be turned into seating for meetings and seminars in no time.



222/90 with solid oak table top, chair 222/21.
Scalable design options to coordinate with the interior design lend project spaces, for instance, very different atmospheres.



Occo Conference 224/43 with a Graph table 300/40 with an oak veneer table top, design: jehs+laub.

When used in meetings, the models with a four-star base and active rocking technology ensure dynamic comfort and casters make them flexible options.



Occo Conference 224/53, Graph table 300/50 with an oak veneer table top, design: jehs+laub. The frames of the table and chairs match each other perfectly. The optional return springs automatically turn the seat shells back to their original positions, which ensures the room looks neat and orderly once people have got up and left.



Table 222/90 with an HPL table top, chair 222/21.



Bar stool, 223/20, chair, 222/10 with a felt pad, chair, 222/11. The bar stools stand apart for the organic form of the seat shells, which convey a feeling of assurance and comfort. Due to its distinctive style and fluid lines, Occo can easily be combined with other items of furniture, such as the Insit seating unit. Insit table 780/2 with an oak veneer table top, Insit bench 782/5, high backrest and 783/60 (customized variant), design: Wolfgang C.R. Mezger.

OCCO. 222 range. Overview of models.

Wilkhahn



OCCO. 222 range. Product types.

Wilkhahn



222/10
Multipurpose chair,
not upholstered,
up to 10 are stackable



222/11
Multipurpose chair,
with seat cushioning,
up to 6 are stackable



222/21
Multipurpose chair,
with seat cushioning



222/30
Visitor chair,
not upholstered



221/10
Multipurpose chair,
not upholstered,
up to 10 are stackable



221/22
Multipurpose chair,
with padding on the inside



221/30
Visitor chair,
not upholstered



221/30
Visitor chair,
with a felt pad



222/32
Visitor chair,
with padding on the inside



222/40
Task chair,
not upholstered



224/14
Upholstered chair,
medium-height backrest



224/23
Upholstered chair,
standard height backrest



224/34
Upholstered chair,
medium-height backrest



224/43
Upholstered chair,
standard height backrest



224/54
Upholstered chair,
medium-height backrest



224/63
Upholstered chair,
standard height backrest

OCCO. 222 range. Product types.

Wilkhahn



223/20
Bar stool,
not upholstered



223/21
Bar stool,
with seat cushioning



223/10
Bar stool,
not upholstered,
bright chrome-plated,
up to 8 are stackable



222/81
Rectangular high table
90 × 190 (35 $\frac{3}{8}$ " × 74 $\frac{3}{8}$ "), H 106 (41 $\frac{1}{4}$ ")



222/81
Table, oak
90 × 190 (35 $\frac{3}{8}$ " × 74 $\frac{3}{8}$ "), H 73 (28 $\frac{3}{4}$ ")



222/61
High table, square
90 × 90 (35 $\frac{3}{8}$ " × 35 $\frac{3}{8}$ "), H 106 (41 $\frac{1}{4}$ ")



222/90
Table, oval
90 × 180 (35 $\frac{3}{8}$ " × 70 $\frac{3}{8}$ "), H 73 (28 $\frac{3}{4}$ ")

Occo, Occo SC, Occo bar stool. 222 range. Upholstery options.

Wilkhahn



222/10 Multipurpose chair, not upholstered



222/10 Multipurpose chair, with a felt pad



222/11 Multipurpose chair, with seat cushioning



222/12 Multipurpose chair, with padding on the inside



223/10 Bar stool, not upholstered



223/11 Bar stool, with seat cushioning

Upholstery materials (not all upholstery materials apply to all variants)

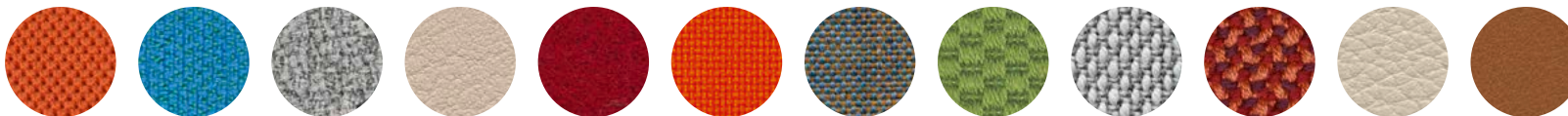

37 Racer | 38 Era | 54 Pitch | 58 Evida | 60 Blend | 66 Lona | 68 Kvadrat Remix 2 | 69 Granite | 91 Kvadrat Steelcut Trio 3 | 92 Credo | 74 Leather | 87 Leather
See the price list or catalog for details of all upholstery materials and more colors

The digital sample colors differ from the originals.

Occo, Occo SC, Occo bar stool. 222 range. Frame versions.

Wilkhahn

Four-leg frame



222/10 Multipurpose chair, Coated frame, not stackable

222/10 Multipurpose chair, Bright chrome-plated frame, stackable

222/20 Multipurpose chair, Solid wood frame, not stackable

Four-star base frame



222/30 Visitor chair, Coated frame, swivel-mounted, not stackable

222/30 Visitor chair, Bright chrome-plated frame, swivel-mounted, not stackable

Five-star base frame on casters



222/40 Task chair, Coated frame, swivel-mounted, not stackable

222/40 Task chair, Bright chrome-plated frame, swivel-mounted, not stackable

Frame surfaces, seat and backrest shells



Black, gray, gray-beige, orange-red, blue-gray or white, textured matte finish

Additional frame surfaces



Bright chrome-plated tubular steel and round steel bar, solid oak

The digital sample colors differ from the originals.
You can find our current fabric collection in our media center.



223/11 Bar stool, Bright chrome-plated skid base, with seat cushioning, not stackable



223/21 Bar stool, Solid wood frame, not stackable

Occo Conference. 224 range. Backrest heights and frame versions.

Wilkhahn

Four-leg frame



224/13 Upholstered chair, standard height backrest, Bright chrome-plated tubular steel frame



224/24 Upholstered chair, medium-height backrest, Solid wood frame

Four-star base frame



224/34 Upholstered chair, medium-height backrest, Bright chrome-plated tubular steel frame

Five-star base frame on casters



224/43 Upholstered chair, standard height backrest, Bright chrome-plated tubular steel frame

Four-star base



224/54 Upholstered chair, medium-height backrest, Bright chrome plated, die-cast aluminum frame

Five-star base on casters



224/64 Upholstered chair, medium-height backrest, Bright chrome plated, die-cast aluminum frame

Frame surfaces, Occo Conference

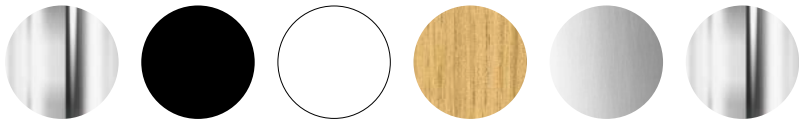

Bright chrome-plated tubular steel, black or white coated with a textured matte finish, solid oak, die-cast aluminum, coated in black or white with a textured matte finish, matte-polished or bright chrome-plated

The digital sample colors differ from the originals.
You can find our current fabric collection in our media center.

Occo table. 222 range. Product types.

Wilkhahn

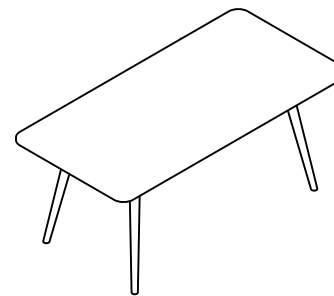
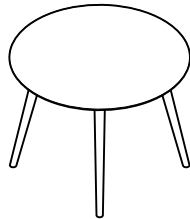
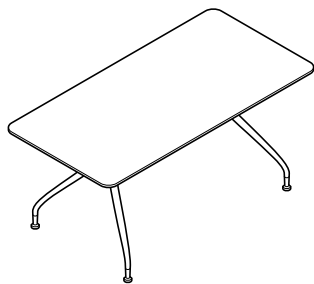
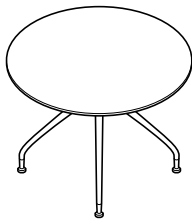
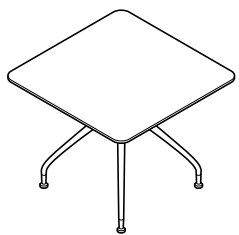

Occo table. 222 range. Table top types.

Wilkhahn



Solid oak table tops, 25 mm (1") thick, edge rounded on the bottom



Table tops in black, through-dyed HPL (High Pressure Laminate), thickness 12 mm (½"), chamfered lipping

Table top groups



Direct coating, black or white through-dyed, veneer variant 1 or 2 (in the case of a solid wood frame, veneer variant 2 isn't possible), solid oak, for further surfaces see the price list or catalog

Edge profiles



Solid wood lipping, rounded on the bottom, straight plastic lipping, chamfered wood lipping or chamfered HPL solid-core lipping

Occo table. 222 range. Frame versions.

Wilkhahn



222/81 Table, oak
90×190 (35¾"×74¾"), H 73 (28¾")

There are round, square, oval and rectangular tables in sitting and standing heights with solid wood frames to match the solid oak chair frames.



222/81 Rectangular high table
90×190 (35¾"×74¾"), H 106 (41¾")

222/61 High table, square
90×90 (35¾"×35¾"), H 106 (41¾")

Diagonal stretchers on the rectangular tables and horizontal stretchers made of bright chrome-plated round steel on the round and square tables in standing heights help to reinforce the conical oak legs.



222/90 Table, oval
90×180 (35¾"×70¾"), H 73 (28¾")

The tubular steel table frames match the design of the star base frames and are optionally available with dark gray glides with a textured matte finish, or lockable casters.

Frame versions

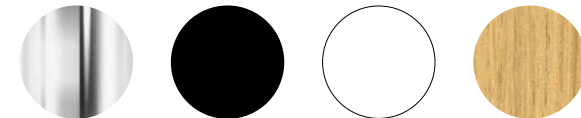

Bright chrome-plated tubular steel, black or white coated with a textured matte finish or solid oak

The digital sample colors differ from the originals.
You can find our current fabric collection in our media center.

Occo, Occo SC, Occo bar stool. 222 range. Accessories.

Wilkhahn

Felt pads for seat shells with no upholstery

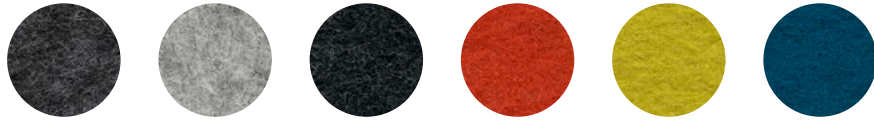

Anthracite, light mottled hue, graphite, mango, verde, deep water



186 Four-wheeled trolley for four-leg models, 222/21 and 222/22 bright chrome-plated (to stack up to 10 chairs without upholstery and up to 6 with seat cushioning and padding on the inside).



221/30 Visitor chair, not upholstered



221/30 Visitor chair, with a felt pad

OCCO. 222 range. Models and dimensions.

Wilkhahn

222/10
Multipurpose chair



222/11
Multipurpose chair



222/12
Multipurpose chair



57
22 1/2"



58
22 7/8"

83
32 5/8"
44
17 3/8"



57
22 1/2"

58
22 7/8"



57
22 1/2"

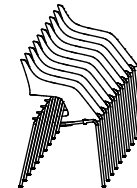

82
32 1/4"

120
47 1/4"



57
22 1/2"

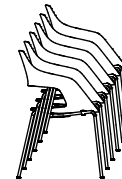

75
29 1/2"

114
44 7/8"

222/20
Multipurpose chair



222/21
Multipurpose chair



222/22
Multipurpose chair



57
22 1/2"



55
21 5/8"

83
32 5/8"
44
17 3/8"



57
22 1/2"

55
21 5/8"

Occo. 222 range. Models and dimensions.

Wilkhahn

222/30
Multipurpose chair



222/31
Multipurpose chair



222/32
Multipurpose chair

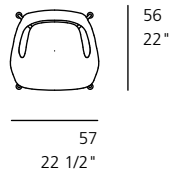
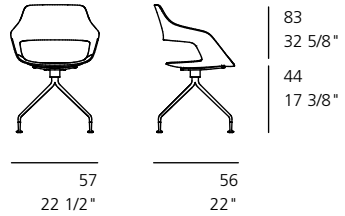

222/40
Multipurpose chair

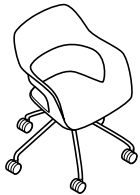

222/41
Multipurpose chair



222/42
Multipurpose chair

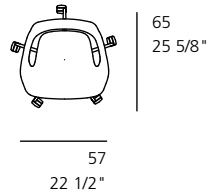
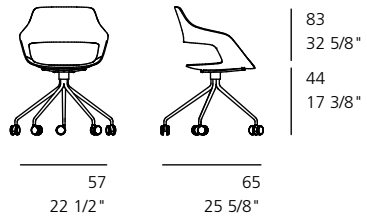

Occo SC. 221 range. Models and dimensions.

Wilkhahn

221/10
Multipurpose chair



221/11
Multipurpose chair



221/12
Multipurpose chair

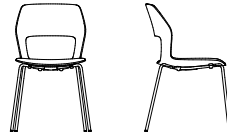

55
21 5/8"

53
20 7/8"

83
32 5/8"
44
17 3/8"



55
21 5/8"

53
20 7/8"

221/20
Multipurpose chair



221/21
Multipurpose chair



221/22
Multipurpose chair

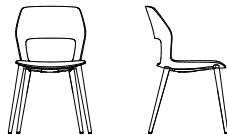

54
21 1/4"

56
22"

83
32 5/8"
44
17 3/8"



54
21 1/4"

56
22"



55
21 5/8"



77
30 3/8"

120
47 1/4"



55
21 5/8"

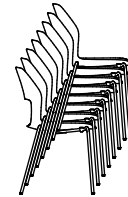

77
30 3/8"

126
49 5/8"

Occo SC. 221 range. Models and dimensions.

Wilkhahn

221/30
Visitor chair



221/31
Visitor chair



221/32
Visitor chair

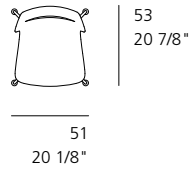
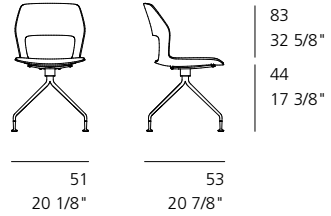

221/40
Task chair

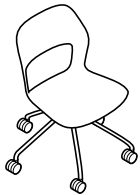

221/41
Task chair



221/42
Task chair

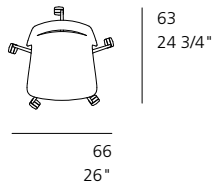
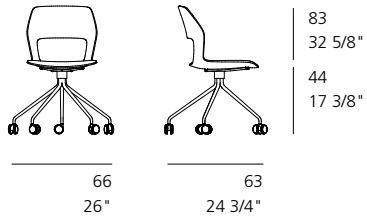

Occo Conference. 224 range. Models and dimensions.

Wilkhahn

224/13
Upholstered chair

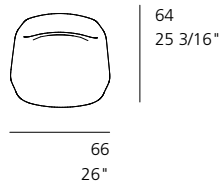
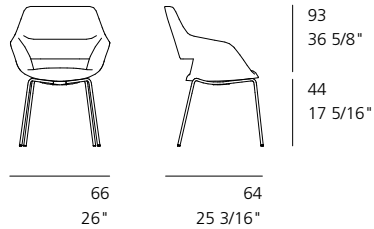

224/23
Upholstered chair

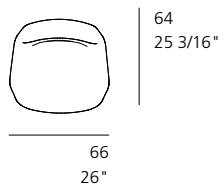
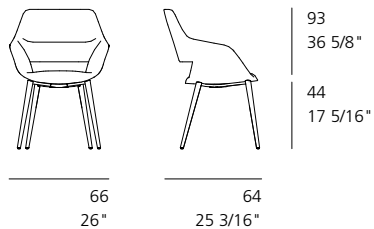

224/14
Upholstered chair

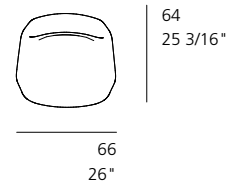
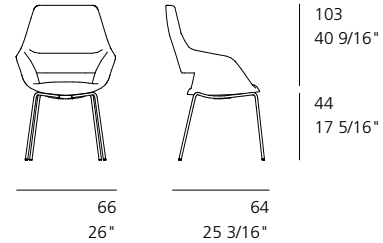

224/24
Upholstered chair

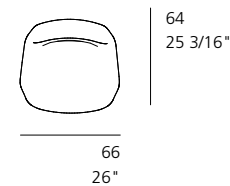
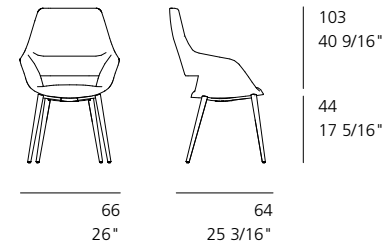
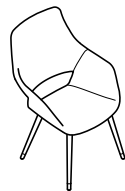

Occo Conference. 224 range. Models and dimensions.

Wilkhahn

224/33
Upholstered chair

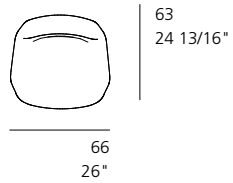
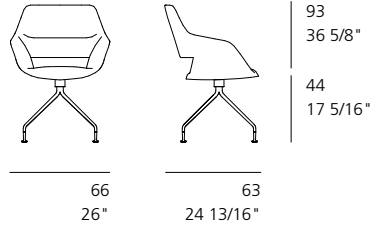

224/34
Upholstered chair

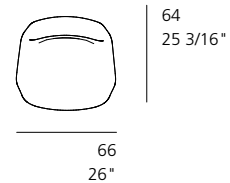
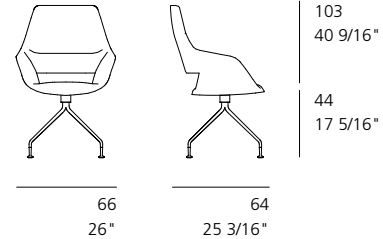
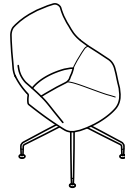

224/43
Upholstered chair

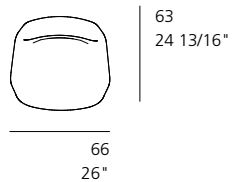
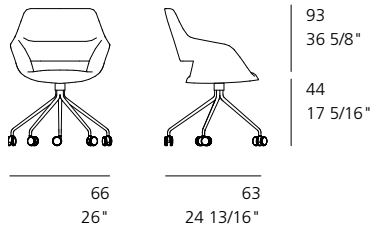
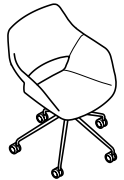

224/44
Upholstered chair

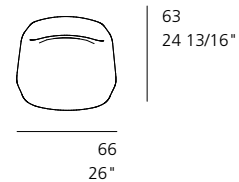
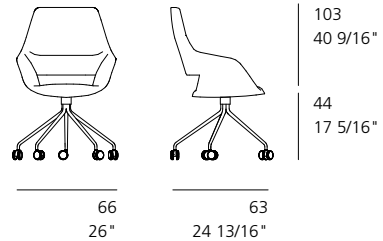
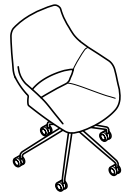

Occo Conference. 224 range. Models and dimensions.

Wilkhahn

224/53

Upholstered chair

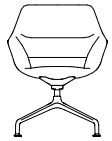

66
26"

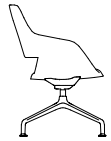

63
24 13/16"

92
36 1/4"
44
17 5/16"

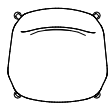

66
26"

63
24 13/16"

224/54

Upholstered chair

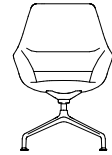

66
26"

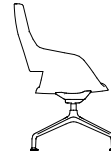

63
24 13/16"

102
40 3/16"
44
17 5/16"

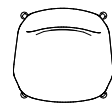

66
26"

63
24 13/16"

224/63

Upholstered chair

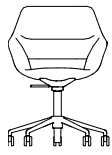
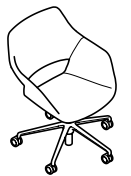

66
26"

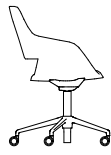

63
24 13/16"

88/98
34 5/8" / 38 9/16"
39/49
15 3/8" / 19 5/16"

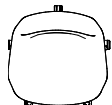

66
26"

63
24 13/16"

224/64

Upholstered chair



66
26"



63
24 13/16"

98/108
38 9/16" / 42 1/2"

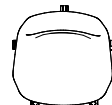

66
26"

63
24 13/16"

Occo Counter stool. 222 range. Models and dimensions.

Wilkhahn

223/10
Counter/bar stool

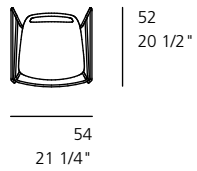
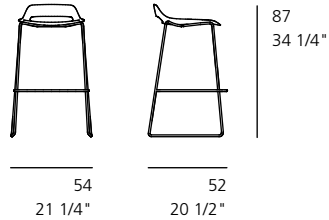
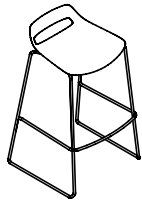

223/10
Counter/bar stool

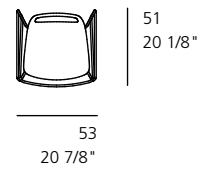
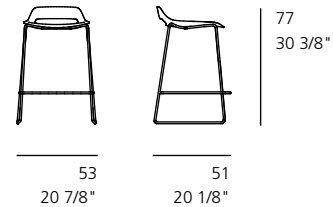
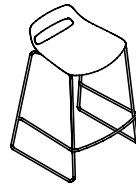

66
26"



53
20 7/8"

111
43 3/4"



66
26"



54
21 1/4"

121
47 5/8"

223/11
Counter/bar stool

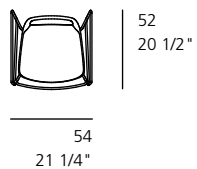
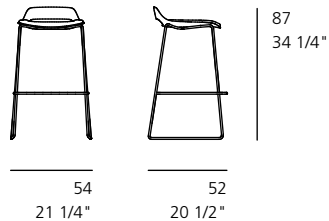
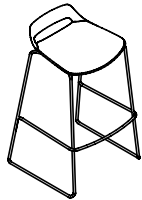

223/11
Counter/bar stool

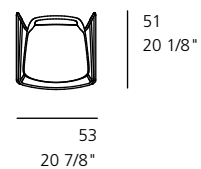
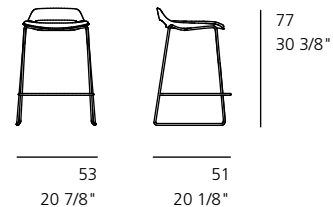
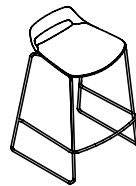

Occo Counter stool. 222 range. Models and dimensions.

Wilkhahn

223/20
Counter/bar stool

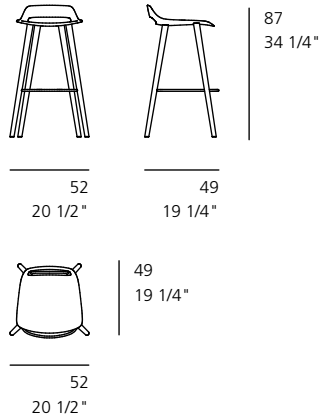

223/20
Counter/bar stool

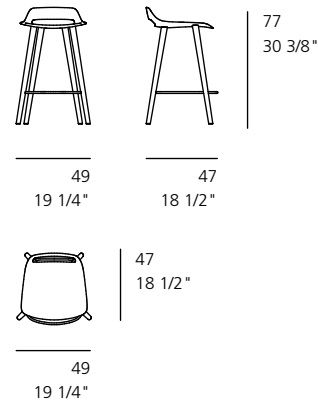

223/21
Counter/bar stool

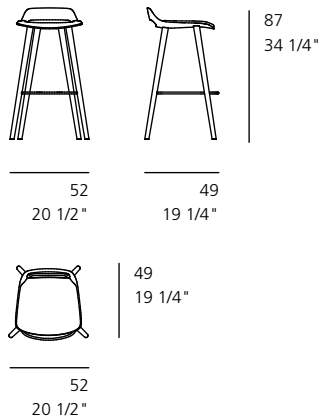

223/21
Counter/bar stool

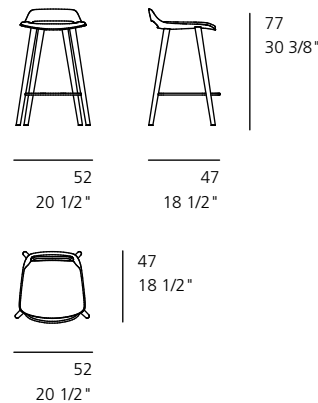

Occo Table. 222 range. Models and dimensions.

Wilkhahn

222/60
Square

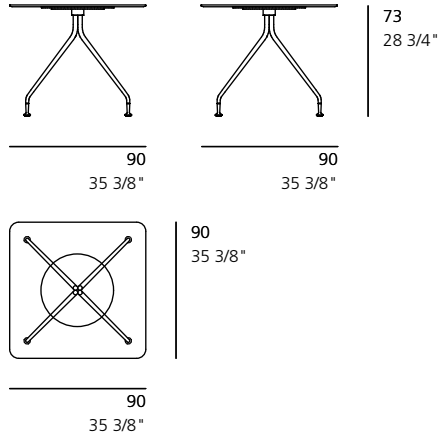
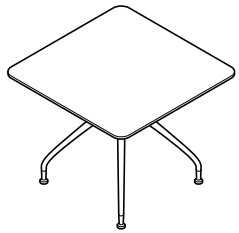

222/70
Round

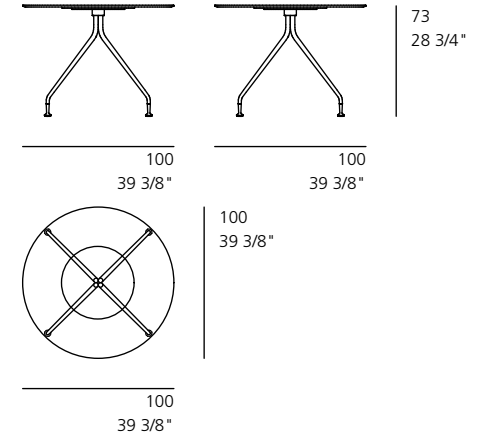
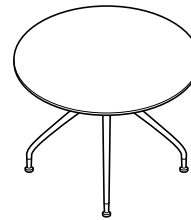

222/80
Rectangular

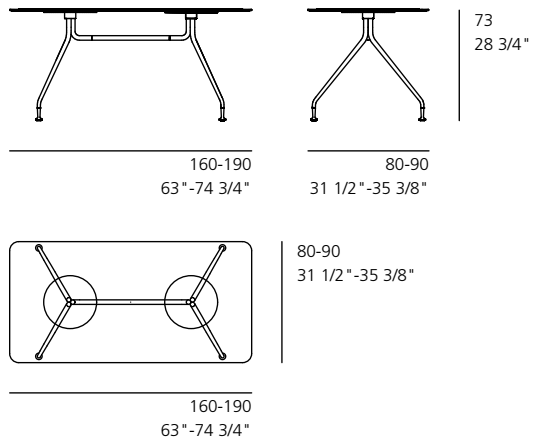
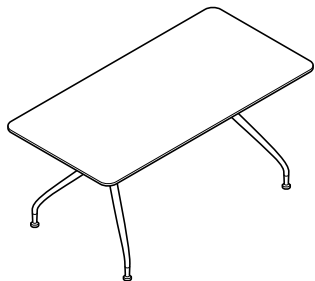

222/90
Oval

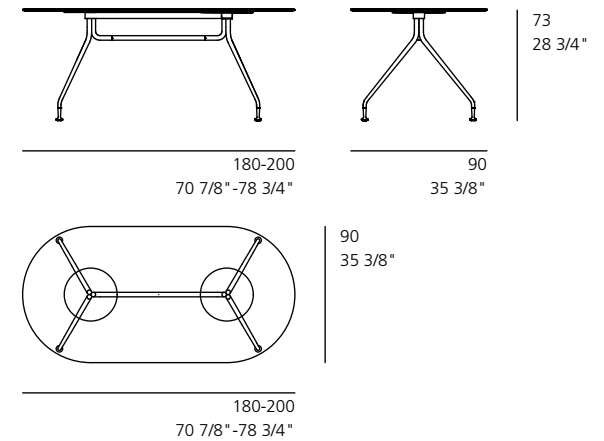
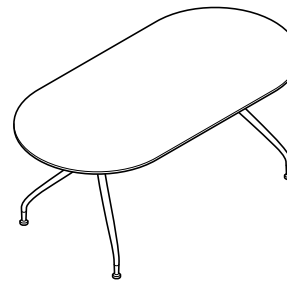

Occo Table. 222 range. Models and dimensions.

Wilkhahn

222/61
Square

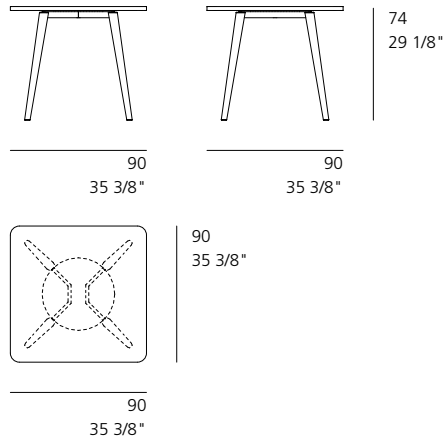
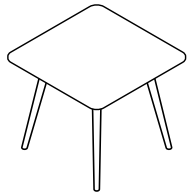

222/61
Square

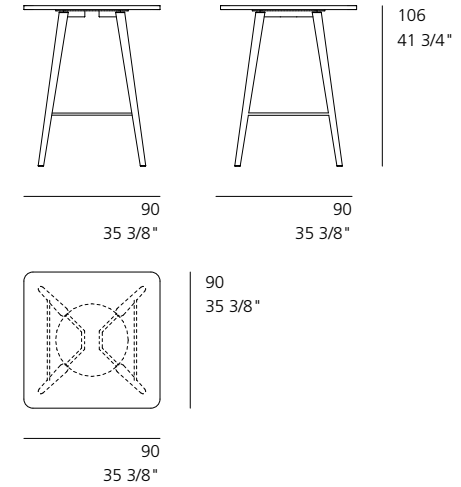

222/71
Round

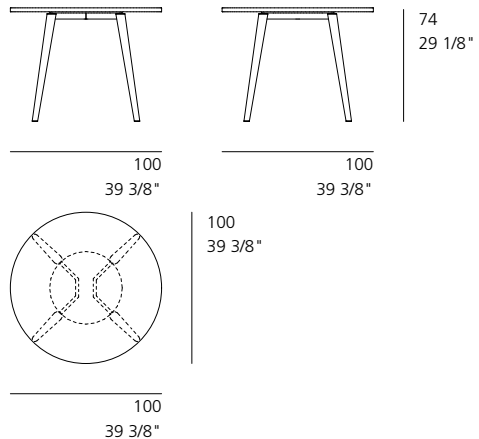
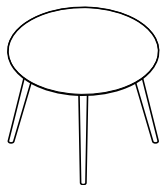

222/71
Round

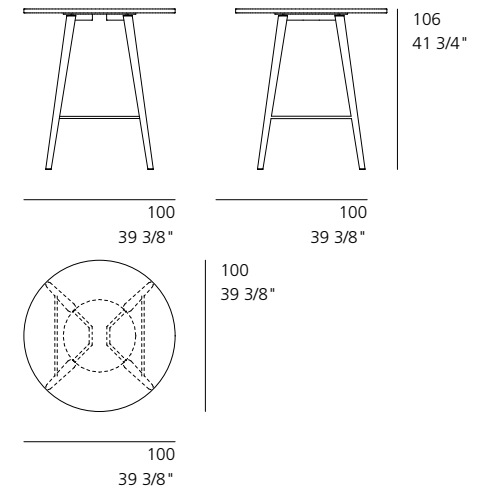

Occo Table. 222 range. Models and dimensions.

Wilkhahn

222/81
Rectangular

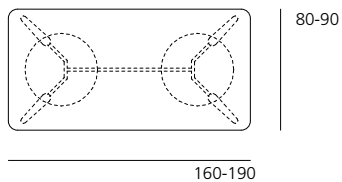
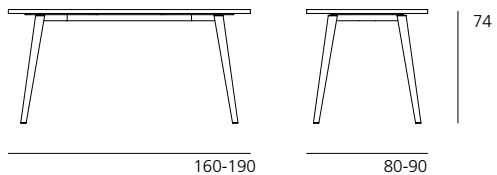
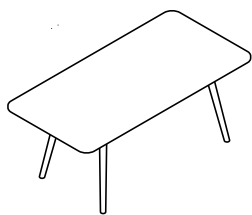

222/81
Rectangular

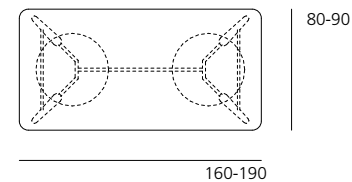
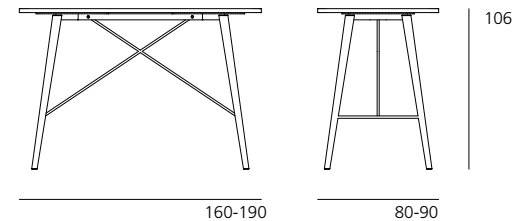

222/91
Oval

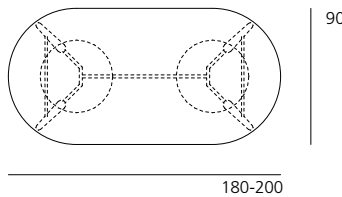
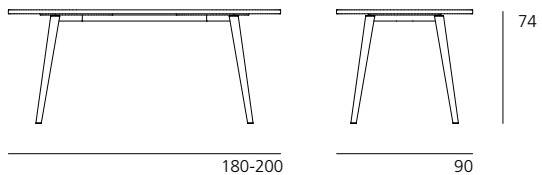
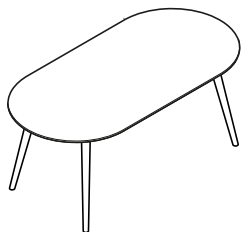

222/91
Oval

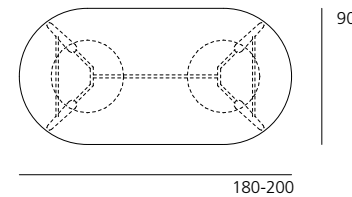
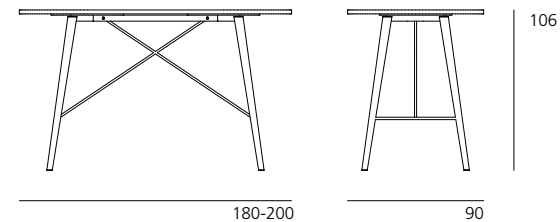

Occo, Occo SC, Occo counter stool. 222 range. Technical details.

Wilkhahn

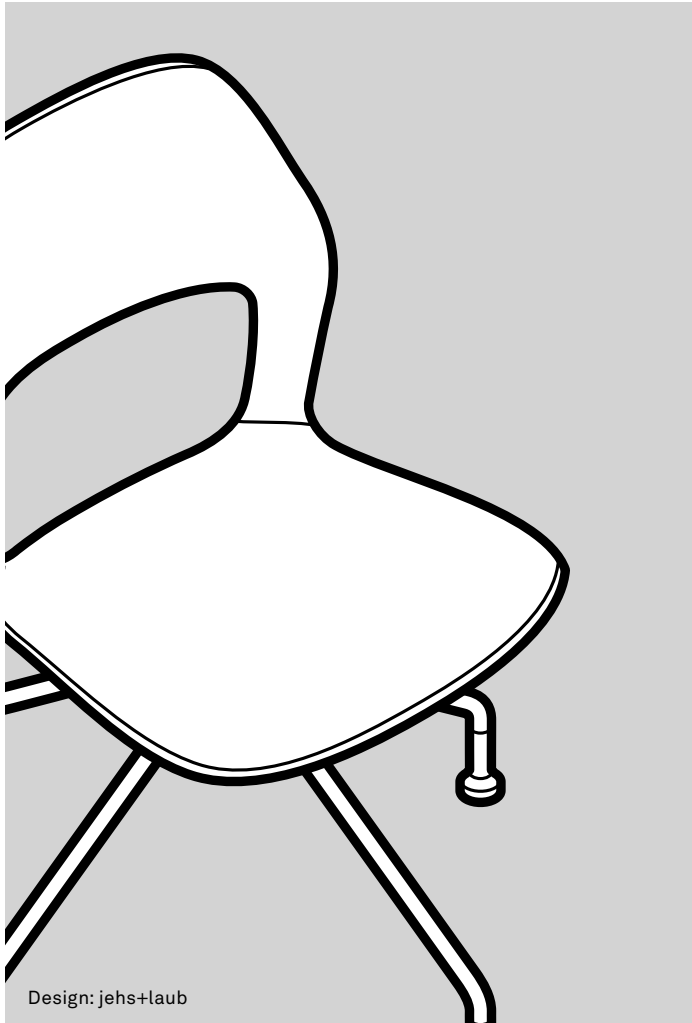

Design: jehs+laub

Function

In conference rooms, open-plan meeting areas or company restaurants: Occo offers superior comfort, enormous versatility and a vast range of design options in a distinctive design language.

Chairs

Frame

Four-leg frame models 221/10, 221/11, 221/12, 222/10, 222/11, 222/12

Tubular steel frame with textured matte finish coated in white, black, gray, gray-beige, orange-red, blue-gray or bright chrome-plated.

Please note: Coated and leather-covered Versions are not stackable. Models 221/10 and 222/10 (shell not upholstered) with four separators made of PUR and frame cover made of plastic (PP) each in dark gray. If the chair is to be stacked, the optional felt pad must be removed because otherwise permanent pressure marks can be caused. Models 221/11, 221/12, 222/11 and 222/12 with stacking guard made of plastic (PP) in dark gray.

Four-leg frame models in solid wood 221/20, 221/21, 221/22, 222/20, 222/21, 222/22

Seat bearer made of tubular steel in dark gray with a textured matte finish to fit onto the seat shell and to attach the four legs made of solid oak with a natural oiled finish.

Four-star base models 221/30, 221/31, 221/32, 222/30, 222/31, 222/32, five-star base models 221/40, 221/41, 221/42, 222/40, 222/41, 222/42

Butted tubular steel frame with a textured matte finish coated in white, black, gray, gray-beige, orange-red, blue-gray or bright chrome-plated with seat bearer made of molded flat steel in dark gray with a textured matte finish to attach to the shell. In the case of four-star base frames, the steel glides are in dark gray with a textured matte finish. Four-leg and four-star base models are fitted with multipurpose glides for soft and hard floorings. For sensitive flooring, please order with extra felt glides (at no extra charge). Five-star base models 221/40, 221/41, 221/42, 222/40, 222/41, 222/42 with twin-wheel swivel casters with load-dependent braking, made of black polypropylene compliant with DIN EN 12529 as the standard version for carpets, optionally with gray polyurethane tire for hard floors.

Skid base bar stools

Skid base with footrest made of tubular steel, 12 mm in diameter, coated with a textured matte finish in white, black, gray, gray-beige, orange-red, blue-gray or bright chrome-plated. Please note: Coated frame versions are not stackable.

Bar stools solid wood, four-leg frame

Seat bearer made of tubular steel in dark gray with a textured matte finish to fit onto the seat shell and to attach the four legs made of solid oak with a natural oiled finish. With tubular steel footrest, bright chrome-plated

Seat and backrest

Unitary, ergonomically molded seat shell with cut-out section, made of reinforced through-dyed polypropylene optionally in white, black, gray, gray-beige, orange-red or blue-gray. Models without upholstery optionally with a felt seat cushion with non-slip coating. In a light mottled hue, anthracite, graphite, mango, verde, deep water. All upholstery in models with seat upholstery or padding on the inside is made of cut foam.

Standards

The multipurpose Occo chairs with four-leg frames comply with the DIN EN 16139-L1 office chair standard.



Information

To ensure quality is maintained we don't offer white leather (74/72). All other standard leather colors are possible. When exposed to ultra violet rays for long periods of time, the colors of plastics can change slightly. Due to the nature of the material, there are slight differences in the color between white table tops with bonded surfaces and HPL table tops and the white Occo plastic chairs. Felt is a natural product. Therefore, there can be differences in the color. These differences are not a justified reason for complaint but underscore the material's uniqueness.

Subject to change.

Occo Conference. 224 range. Technical details.

Wilkhahn

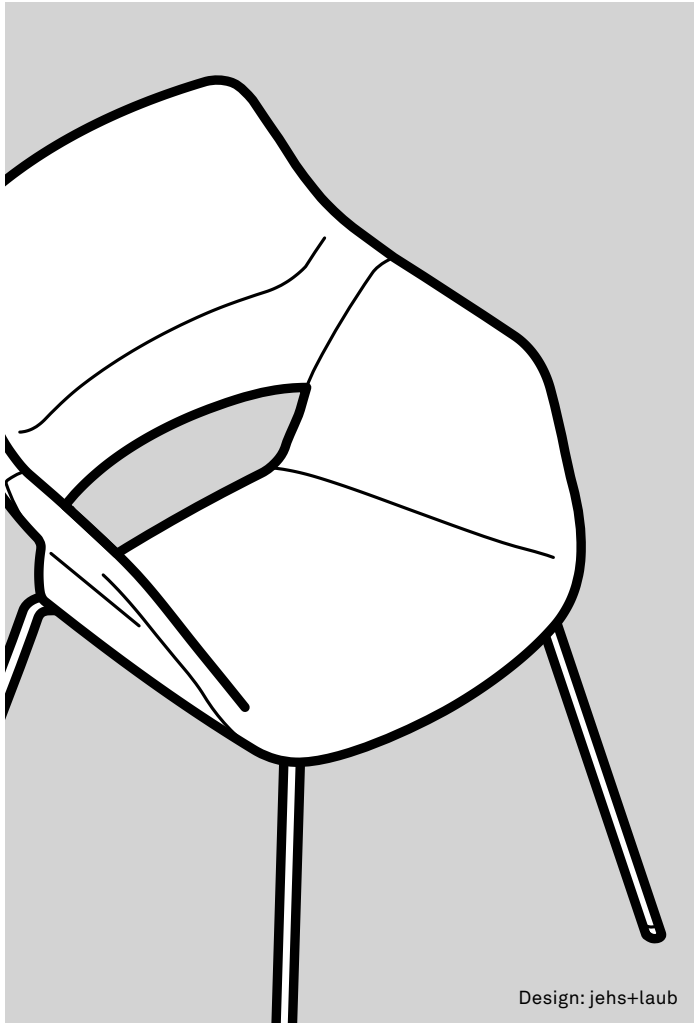

Design: jehs+laub

Function

A versatile chair range in a high-quality design, with six types of frame, two backrest heights and a large variety of covers, configurable for all sorts of different areas ranging from lounges where people work, areas in the middle of rooms, offices, lobbies, meeting spaces and conference rooms, as well as company restaurants, bistros and dining rooms. Excellent ergonomics and superb comfort due to upholstered areas with different levels of firmness. Fully upholstered seat body with integrated armrest pads and a distinctive cut-out section between the seat and the backrest to marry a lightweight appearance with the comforting appeal of a shell chair. With replaceable covers, whose stitching and clamps trace the three-dimensional contours and zones of the upholstered component precisely and in a form-fit way.

Frame

Four-leg frame, steel, models 224/13, 224/14

Tubular steel frame, 18 mm in diameter, with a textured matte finish coated in white or black or with bright chrome plating.

Solid wood four-leg frame, models 224/23, 224/24

Tubular steel seat bearer in dark gray with a textured matte finish to attach the seat shell and the four conical legs made of solid oak with a natural oiled finish. Four-leg frames with multipurpose glides for soft and hard flooring. For sensitive flooring, please order with extra felt glides (at no extra charge).

Four-star base frame, models 224/33, 224/34

Butted tubular steel frame, with a textured matte finish, coated in white or black or with bright chrome plating, with steel glides in dark gray with a textured matte finish, with multipurpose glides for soft and hard flooring, for sensitive flooring, please order with extra felt glides (at no extra charge).

Five-star base frame, models 224/43, 224/44

Butted tubular steel frame, with a textured matte finish, coated in white or black or with bright chrome plating with twin-wheel swivel casters with load-dependent braking, made of black polyamide, compliant with DIN EN 12529 as the standard version for carpets, optionally available with gray polyurethane tire for hard flooring.

Four-star base, models 224/53, 224/54

Four-star base made of die-cast aluminum with a textured matte finish, coated in white or black, matte polished or with bright chrome plating, with a swivel-mounted stainless steel column (optionally with swivel-return mechanism) and active rocking technology, a lever can lock it in a horizontal neutral 0 position, with die-cast aluminum housing, matte polished. Black, multipurpose glides made of plastic for all types of flooring. Optionally with base glides with a larger contact area for sensitive floorings, either to match the star base with a textured matte finish, coated in white or black, matte chrome-plated (matte-polished star base) or bright chrome plated (with a bright chrome-plated star base). Black polyamide glides for carpets. For hard floors (e.g. stone), please

order with soft TPU, for wooden floors (e. g. parquet) with additional felt. These glides change the seating height to 44 cm (17 $\frac{1}{2}$ ""). Optionally, compliant with DIN EN 1335 and ANSI/BIFMA X 5.1, with twin-wheel swivel casters with load-dependent braking made of black polyamide compliant with DIN EN 12529, as the standard version for carpets, with gray polyurethane tire for hard flooring. The casters change the seating height to 45 cm (17 $\frac{3}{4}$ "").

Five-star base, models 224/63, 224/64

Five-star base made of die-cast aluminum with a textured matte finish, coated in white or black, matte polished or with bright chrome plating, with swivel-mounted gas lift column and active rocking technology, a lever allows the height to be precision adjusted and locked in a horizontal neutral 0 position, with a die-cast aluminum housing, matte polished. Compliant with DIN EN 1335 and ANSI/BIFMA X 5.1 with twin-wheel swivel casters with load-dependent braking made of black polyamide compliant with DIN EN 12529, as the standard version for carpets; with gray polyurethane tire for hard flooring.

Subject to change.

Occo Conference. 224 range. Technical details.

Wilkhahn

Seat and backrest

Unitary seat shell with integrated armrests and backrest shell, each made of molded plywood, fully padded and covered with PUR molded foam, in different levels of firmness depending on the are upholstered. Seat and backrest shell joined with concealed screws. Covers with contour-creating stitching in the seat and backrest, fixed to the upholstery with clamps, replaceable.

Standards

The models with four-leg frames, five-star bases and star bases comply with DIN EN 16139, DIN EN 1728 and ANSI/BIFMA X 5.1 (currently undergoing testing).

Information

To ensure quality is maintained we don't offer white leather (74/72). All other standard colors of leather are possible.

Occo Table. 222 range. Technical details.

Wilkhahn

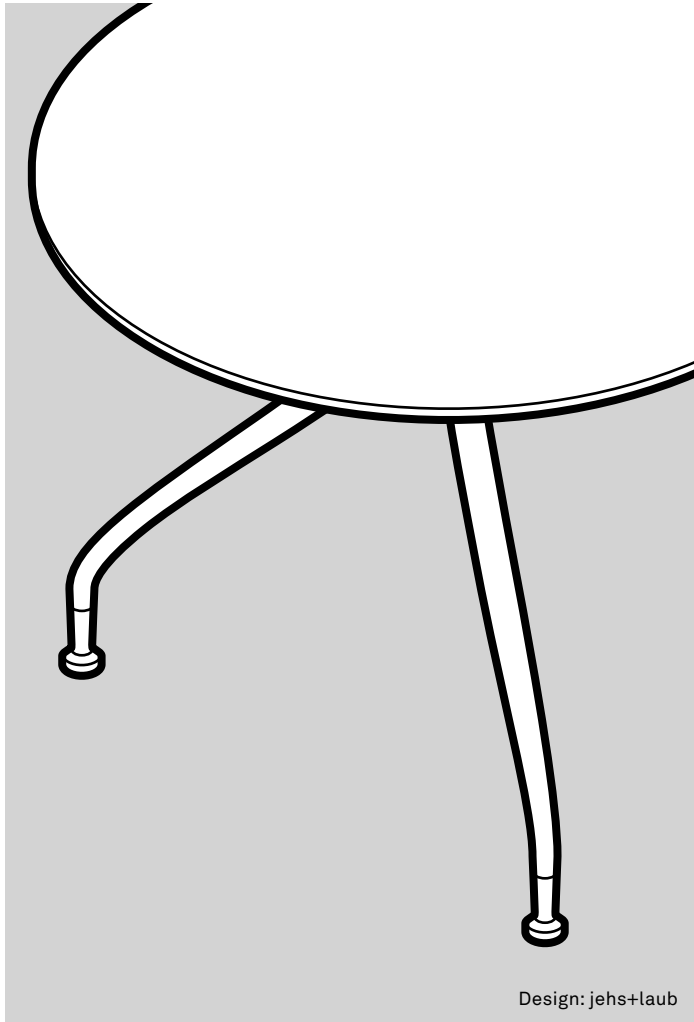

Design: jehs+laub

Tables

Frame

Models 222/60 and 222/70 with four star-base table legs

made of butted tubular steel, optionally coated with a textured matte finish in black or white or bright chrome plating.

Models 222/80 and 222/90

Table legs are connected by a crossbeam. Models as of 90 × 180 cm (35 $\frac{5}{8}$ " × 70 $\frac{7}{8}$ ") incl. extra reinforcement uprights in dark gray with a textured matte finish. All table top bearers and glides made of steel in dark gray with a textured matte finish. With multipurpose glides for soft and hard floorings. In the case of wooden floorings (e.g. parquet) please order with extra felt glides (at no extra charge). Adjustment range: 10 mm ($\frac{3}{8}$ "). Optional lockable, height-adjustable, swivel casters with a black polyamide tire as the standard version for carpeted floors; casters available with a polyurethane tire for hard floors (please specify when ordering).

Models 222/61, 222/71, 222/81, 222/91

with a four-leg frame, solid oak, with a natural oiled finish.

Models 222/81 and 222/91

in standing height with a center underframe and diagonal stretcher made of bright chrome-plated round steel.

Models 222/61 and 222/71

in standing height and with a horizontal stretcher made of bright chrome-plated round steel. With multipurpose glides for soft and hard floorings. In the case of wooden floorings (e.g. parquet) please order with extra felt glides (at no extra charge).

Core panels on table top, table top group 2 – veneer variant 1 and 2

MDF (medium density fiberboard), table top thickness 26 mm (1")
Variant 1: Beech or oak veneer based on Wilkhahn woodstain color samples with chamfered wood lipping, to color-match the veneer as far as possible, models 222/61, 222/71, 222/81, 222/91 only available in the oak veneer version.

Variant 2: (only models 222/60, 222/70, 222/80, 222/90) walnut or elm veneer from the Wilkhahn woodstain color samples with chamfered wood lipping, color-matched as far as possible with the veneer.

Table height 74 cm (29 $\frac{1}{8}$ ")
standing height 106 cm (41 $\frac{3}{4}$ ")

Table top group 5 – with bonded surface

Table top thickness 25 mm thick, bonded melamine resin surface, in white or black with straight plastic lipping color-matched with the surface.

Table height 74 cm (29 $\frac{1}{8}$ ")
standing height 106 cm (41 $\frac{3}{4}$ ")

Table top group 7 – black/white through-dyed

HPL (High Pressure Laminate) table top, 12 mm thick in black or white, chamfered lipping.
Table height 73 cm (28 $\frac{3}{4}$ ")
standing height 105 cm

Table top group 10 – solid wood

Table top thickness 25 mm, solid oak from the Wilkhahn woodstain color samples, natural oiled finish, lipping, rounded on the bottom.

Table height 74 cm (29 $\frac{1}{8}$ ")
standing height 106 cm (41 $\frac{3}{4}$ ")

Information

Due to the nature of the material, there are slight differences in the color between white table tops with bonded surfaces and HPL table tops and the white Occo plastic chairs.

Edge profiles



E4 – 1 solid wood, rounded on the bottom



E2 – 3 straight plastic lipping



E2 – 5 chamfered wood lipping, 12 mm

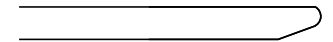

E5 – 1 HPL-solid-core, chamfered lipping, 4 mm radius

Subject to change.

Occo. 222 range. Awards/standards/certificates.

Wilkhahn

Awards



Not all awards apply to all types.

Product certificates / product standards



Not all certificates / standards apply to all types.

Company's certificates, memberships

